

HF (13.56 MHz)
BIS M-4008-048-002-ST4
 Order Code: BIS017A

BALLUFF

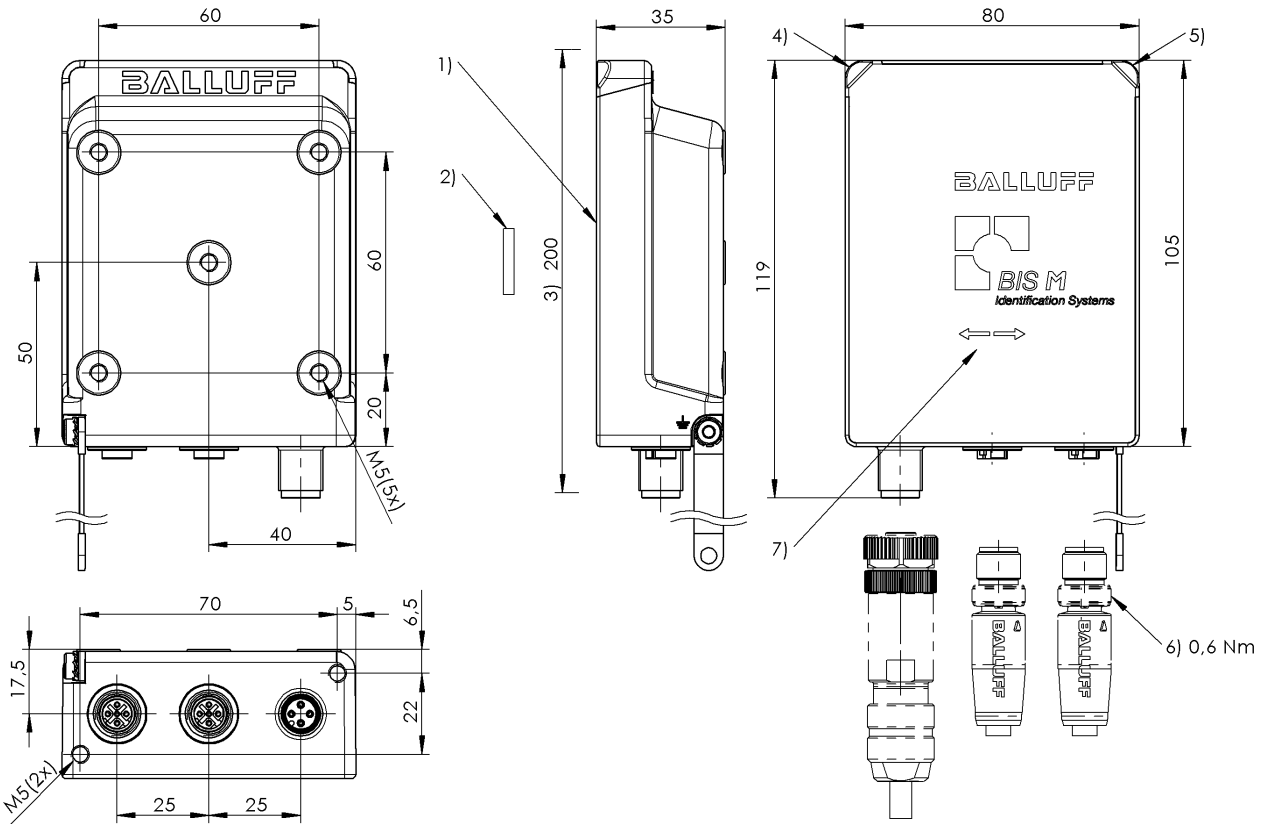

- 1) Sensing surface
- 2) Data carrier
- 3) Clear zone
- 4) LED (Power)
- 5) LED (CP)
- 6) Tightening torque
- 7) Read/write axis



Basic features

Antenna type	Rod
Approval/Conformity	CE WEEE EAC
Principle of operation	Read/write device

Display/Operation

Function indicator	Power, LED green CP (Code tag present), LED yellow Link Port 1, LED green System Failure Status, LED red BUS Failure Status, LED red Activity Port 2, LED yellow Activity Port 1, LED yellow Link Port 2, LED green
--------------------	--

HF (13.56 MHz)
BIS M-4008-048-002-ST4
Order Code: BIS017A



Electrical connection

Connection (COM 1)	Port 1: M12x1-Female, 4-pin, D-coded
Connection (COM 2)	Port 2: M12x1-Female, 4-pin, D-coded
Connection (supply voltage IN)	M12x1-Male, 4-pin, A-coded

Electrical data

Current consumption max. at 24 V DC	150 mA
Nominal voltage	24 VDC
Operating voltage Ub	24 V DC LPS Class 2
Residual ripple max.	10 %

Environmental conditions

Ambient temperature	0...70 °C
EN 60068-2-27, Shock	yes
EN 60068-2-32 Free fall	yes
EN 60068-2-6, Vibration	yes
IP rating	IP67, with connector
Storage temperature	-20...85 °C

Functional Characteristics

Supported data carrier types	DIN ISO 15693 DIN ISO 15693 (High Memory)
-------------------------------------	---

Functional safety

MTTF (40 °C)	68 a
---------------------	------

Material

Housing material	Zinc, Die casting
-------------------------	-------------------

Mechanical data

Application weight	490.00 g
Dimension	80 x 35 x 119 mm
Installation	metal-free (clear zone) on metal flush in metal

Output/Interface

Interface	Profinet I/O (IRT) Profinet I/O (IRT) 2-port switch
------------------	--

Remarks

Only for data carriers acc. to ISO 15693.
 For basic equipment: Accessories see www.balluff.com
 When installing, the technical standards and regulations of the corresponding countries must be observed.
 Values are under rated conditions unless otherwise specified.
 For more information about MTTF and B10d see MTTF / B10d Certificate

Indication of the MTTF- / B10d value does not represent a binding composition and/or life expectancy assurance; these are simply experiential values with no warranty implications. These declared values also do not extend the expiration period for defect claims or affect it in any way.

Connector Drawings

1) View towards connector
2) Female 4-pin/ Function
3) Coding D

PROFINET Port 1/2

2)

1	—	+TX
2	—	+RX
3	—	-TX
4	—	-RX

1) View towards connector
2) Male 4-pin/ Function

2)

Power

1	—	+24V DC
2	—	n.c.
3	—	0V
4	—	n.c.

HF (13.56 MHz)
BIS M-4008-048-002-ST4
Order Code: BIS017A



Help Views

HF (13.56 MHz)

BIS M-4008-048-002-ST4

Order Code: BIS017A

BALLUFF

BIS M-4008-002

	BIS M-150-02/A	BIS M-151-02/A	BIS M-150-02/A	BIS M-151-02/A
passende Datenträger Appropriate data carriers				
Freizone Datenträger in mm (a) Data carrier clear zone in mm	>200 >200	>200 >200	>200 >200	>200 >200
Freizone Datenträger in mm (b) Data carrier clear zone in mm	>200 >200	>200 >200	>200 >200	>200 >200
Datenträger Metall-Montagefläche 40x22 Data carrier metal mounting surface 40x22	0-65 0-65	0-65 0-65		
Datenträger Metall-Montagefläche ≥ 200x200 Data carrier metal mounting surface ≥ 200x200				
Schreibabstand in mm Write distance in mm	0-65 0-65	0-65 0-65	0-60 0-60	0-45 0-45
Lesebstand in mm Read distance in mm	0-65 0-65	0-65 0-65	0-60 0-60	0-45 0-45
Versatz in mm bei Abstand von Offset in mm at distance	0-65 0-65 X Y	0-65 0-65 Y X	0-60 0-60 X Y	0-45 0-45 Y X
	0 ±70 ±30	±70 ±30	±65 ±30	±50 ±25
	5 ±70 ±30	±70 ±30	±65 ±30	±50 ±25
	10 ±70 ±30	±70 ±30	±65 ±30	±50 ±25
	15 ±70 ±30	±70 ±30	±65 ±30	±50 ±25
	20 ±70 ±30	±70 ±30	±65 ±30	±50 ±25
	25 ±65 ±25	±65 ±25	±60 ±25	±40 ±20
	30 ±65 ±25	±65 ±25	±60 ±25	±40 ±20
	35 ±65 ±25	±65 ±25	±60 ±25	±40 ±20
	40 ±65 ±25	±65 ±25	±60 ±25	±30 ±15
	45 ±40 ±20	±40 ±20	±40 ±20	±5 ±5
	50 ±40 ±20	±40 ±20	±40 ±20	
	55 ±40 ±20	±40 ±20	±40 ±20	
	60 ±40 ±20	±40 ±20	±20 ±10	
	65 ±20 ±10	±20 ±10		
	70			
	75			
	80			

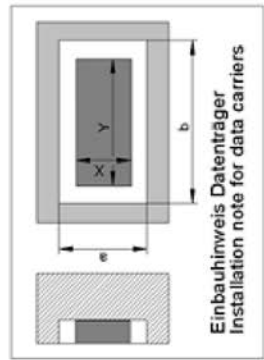

HF (13.56 MHz)

BIS M-4008-048-002-ST4

Order Code: BIS017A

BALLUFF

BIS M-4008-002

	BIS M-152-03/A					
passende Datenträger						
Appropriate data carriers						
Freizone Datenträger in mm (a)	>200	>200				
Data carrier clear zone in mm						
Freizone Datenträger in mm (b)	>200	>200				
Data carrier clear zone in mm						
Freizone Datenträger in mm (c)	>50	>50				
Data carrier clear zone in mm						
Schreibabstand in mm	0-35	0-35				
Write distance in mm						
Lesebestand in mm	0-35	0-35				
Read distance in mm						
Versatz in mm	X	Y				
bei Abstand von	0	±44	±22			
	5	±44	±22			
	10	±44	±22			
	15	±40	±20			
	20	±40	±20			
	25	±32	±18			
	30	±32	±18			
	35	±10	±3			
	40					
	45					
	50					
	55					
	60					
	80					
	95					
	100					
	110					

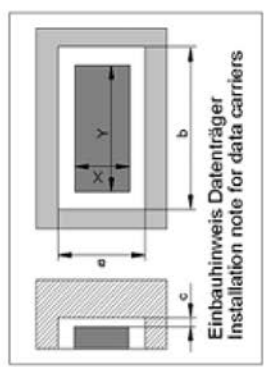

BIS M-4008-002

	BIS M-153-02/A	BIS M-153-02/A	BIS M-153-1x/A	BIS M-153-20/A	BIS M-153-20/A
passende Datenträger Appropriate data carriers					
Freizone Datenträger in mm (a) Data carrier clear zone in mm	>240 >240	>240 >240	>240 >240	>240 >240	>240 >240
Freizone Datenträger in mm (b) Data carrier clear zone in mm	>480 >480	>480 >480	>480 >480	>480 >480	>480 >480
Freizone Datenträger in mm (c) Data carrier clear zone in mm	>50 >50	>0 >0	>50 >50	>50 >50	>0 >0
Schreibabstand in mm Write distance in mm	0-100 0-100	0-100 0-100	0-55 0-55	5-75 5-75	5-75 5-75
Lesabstand in mm Read distance in mm	0-100 0-100	0-100 0-100	0-55 0-55	5-75 5-75	5-75 5-75
Versatz in mm bei Abstand von Offset in mm at distance	X Y 0 ±100 ±40 5 ±100 ±40 10 ±100 ±40 20 ±100 ±40 25 ±100 ±40 30 ±100 ±40 40 ±100 ±40 50 ±80 ±35 55 ±80 ±35 60 ±80 ±35 70 ±80 ±35 75 ±80 ±35 80 ±80 ±35 95 ±55 ±25 100 ±30 ±10 110 120	X Y ±100 ±40 ±100 ±40 ±100 ±40 ±100 ±40 ±100 ±40 ±100 ±40 ±100 ±40 ±80 ±35 ±80 ±35 ±80 ±35 ±80 ±35 ±80 ±35 ±55 ±25 ±30 ±10	X Y ±65 ±30 ±65 ±30 ±65 ±30 ±65 ±30 ±60 ±25 ±60 ±25 ±60 ±25 ±30 ±20 ±20 ±10	X Y ±80 ±35 ±80 ±35 ±80 ±35 ±80 ±35 ±70 ±30 ±70 ±30 ±70 ±30 ±40 ±25 ±40 ±25 ±40 ±25 ±15 ±10	X Y ±80 ±35 ±80 ±35 ±80 ±35 ±80 ±35 ±70 ±30 ±70 ±30 ±70 ±30 ±40 ±25 ±40 ±25 ±40 ±25 ±15 ±10

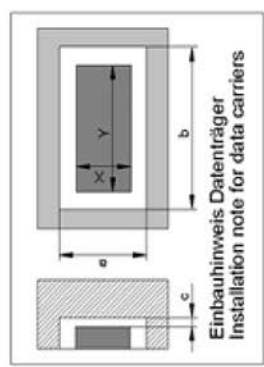

HF (13.56 MHz)

BIS M-4008-048-002-ST4

Order Code: BIS017A

BALLUFF

BIS M-4008-002

	BIS M-155-1x/A	BIS M-155-1x/A	BIS M-156-1x/A	BIS M-156-1x/A
passende Datenträger Appropriate data carriers				
Freizone Datenträger in mm (a) Data carrier clear zone in mm	>200 >200	>200 >200	>200 >200	>200 >200
Freizone Datenträger in mm (b) Data carrier clear zone in mm	>200 >200	>200 >200	>200 >200	>200 >200
Datenträger Metall-Montagefläche 40x22 Data carrier metal mounting surface 40x22	0-42 0-42	0-42 0-42	0-42 0-42	0-42 0-42
Datenträger Metall-Montagefläche ≥ 200x200 Data carrier metal mounting surface ≥ 200x200	0-42 0-42	0-42 0-42	0-42 0-42	0-42 0-42
Schreibabstand in mm Write distance in mm	0-42 0-42	0-42 0-42	0-42 0-42	0-42 0-42
Lesabstand in mm Read distance in mm	0-42 0-42	0-42 0-42	0-42 0-42	0-42 0-42
Versatz in mm bei Abstand von at distance	X Y ±45 ±25 ±45 ±25 ±45 ±25 ±45 ±25 ±45 ±25 ±30 ±18 ±30 ±18 ±30 ±18 ±20 ±10 ±10 ±5	X Y ±45 ±25 ±45 ±25 ±45 ±25 ±45 ±25 ±45 ±25 ±30 ±18 ±30 ±18 ±30 ±18 ±20 ±10 ±10 ±5	X Y ±45 ±25 ±45 ±25 ±45 ±25 ±45 ±25 ±45 ±25 ±30 ±18 ±30 ±18 ±30 ±18 ±20 ±10 ±10 ±5	X Y ±45 ±25 ±45 ±25 ±45 ±25 ±45 ±25 ±45 ±25 ±30 ±18 ±30 ±18 ±30 ±18 ±20 ±10 ±10 ±5
0	X	X	X	X
5	±45	±45	±45	±45
10	±45	±45	±45	±45
15	±45	±45	±45	±45
20	±45	±45	±45	±45
25	±30	±30	±30	±30
30	±30	±30	±30	±30
35	±30	±30	±30	±30
40	±20	±20	±20	±20
42	±10	±10	±10	±10
45	±5	±5	±5	±5
50				
55				
60				
65				
70				
75				

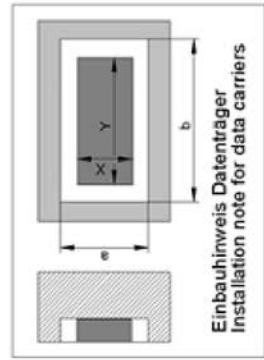

BIS M-4008-002

	BIS M-155-20/A	BIS M-155-20/A	BIS M-156-20/A	BIS M-156-20/A
passende Datenträger Appropriate data carriers				
Freizone Datenträger in mm (a) Data carrier clear zone in mm	>200 >200	>200 >200	>200 >200	>200 >200
Freizone Datenträger in mm (b) Data carrier clear zone in mm	>200 >200	>200 >200	>200 >200	>200 >200
Datenträger Metall-Montagefläche 40x22 Data carrier metal mounting surface 40x22	0-68 0-68		0-68 0-68	
Datenträger Metall-Montagefläche ≥ 200x200 Data carrier metal mounting surface ≥ 200x200		0-68 0-68		0-58 0-58
Schreibabstand in mm Write distance in mm	0-68 0-68		0-68 0-68	
Lesebstand in mm Read distance in mm	0-68 0-68		0-68 0-68	
Versatz in mm bei Abstand von Offset in mm at distance	0-68 0-68 X Y 0 ±75 ±32 5 ±75 ±32 10 ±75 ±32 15 ±75 ±32 20 ±75 ±32 25 ±70 ±28 30 ±70 ±28 35 ±70 ±28 40 ±70 ±28 45 ±50 ±25 50 ±50 ±25 55 ±50 ±25 58 ±50 ±25 65 ±50 ±25 68 ±20 ±10 75 80	0-68 0-68 X Y ±75 ±32 ±75 ±32 ±75 ±32 ±75 ±32 ±75 ±32 ±70 ±28 ±70 ±28 ±70 ±28 ±70 ±28 ±50 ±25 ±50 ±25 ±50 ±25 ±50 ±25 ±50 ±25 ±20 ±10	0-68 0-68 X Y ±75 ±32 ±75 ±32 ±75 ±32 ±75 ±32 ±75 ±32 ±70 ±28 ±70 ±28 ±70 ±28 ±70 ±28 ±50 ±25 ±50 ±25 ±50 ±25 ±50 ±25 ±50 ±25 ±20 ±10	0-58 0-58 Y X ±60 ±28 ±60 ±28 ±60 ±28 ±60 ±28 ±60 ±28 ±55 ±25 ±55 ±25 ±55 ±25 ±55 ±25 ±35 ±18 ±35 ±18 ±35 ±18 ±15 ±5

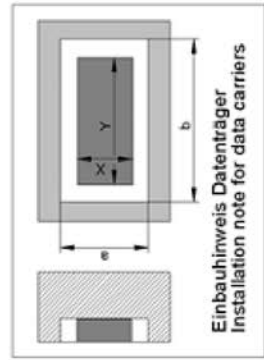

HF (13.56 MHz)

BIS M-4008-048-002-ST4

Order Code: BIS017A

BALLUFF

BIS M-4008-002

	BIS M-191-02/A	BIS M-191-02/A	BIS M-191-02/A	BIS M-191-02/A
passende Datenträger Appropriate data carriers				
Freizone Datenträger in mm (a) Data carrier clear zone in mm	>27	>27	>27	>27
Freizone Datenträger in mm (b) Data carrier clear zone in mm	>27	>27	>27	>27
Datenträger auf Metall-Montagefläche Data carrier on metal mounting surface	0-30	0-30	0-30	0-30
Montage Metallfrei Mounting non-metal	0-55	0-55		
Schreibabstand in mm Write distance in mm	0-55	0-55	0-30	0-30
Lesabstand in mm Read distance in mm	0-55	0-55	0-30	0-30
Versatz in mm bei Abstand von Offset in mm at distance	X 0 ±65 ±28 5 ±65 ±28 10 ±65 ±28 15 ±65 ±28 20 ±65 ±28 25 ±55 ±25 30 ±55 ±25 35 ±55 ±25 40 ±55 ±25 45 ±40 ±20 50 ±40 ±20 55 ±5 ±5 60 65 70 75	Y ±44 ±24 ±44 ±24 ±44 ±24 ±38 ±21 ±38 ±21 ±25 ±15 ±8 ±5	X ±44 ±24 ±44 ±24 ±44 ±24 ±38 ±21 ±38 ±21 ±25 ±15 ±8 ±5	Y ±44 ±24 ±44 ±24 ±44 ±24 ±38 ±21 ±38 ±21 ±25 ±15 ±8 ±5

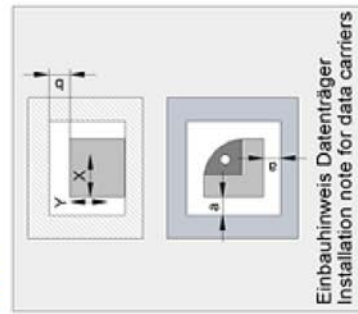

Einbauhinweis Datenträger
Installation note for data carriers